

**icanCLAVE**

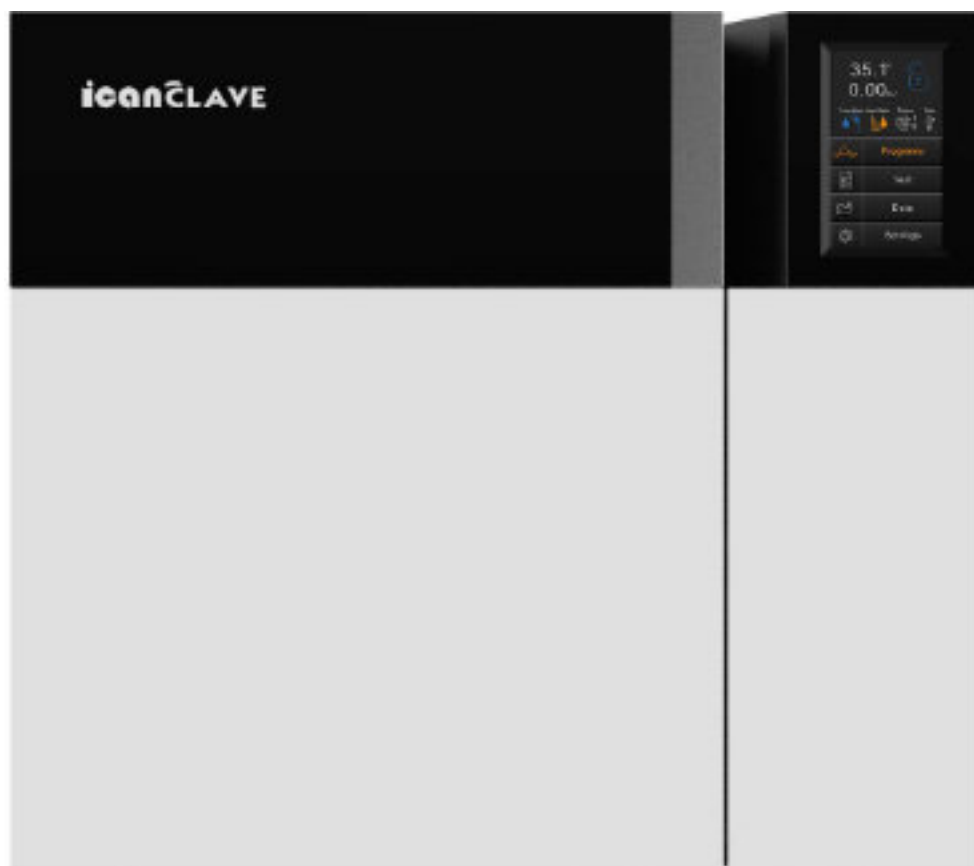

## Instructions Manual

For Models: STE-18-T  
STE-23-T

Thank you for choosing our steam sterilizer.

Prior to operating this instrument, please read the operations manual carefully and follow all installation instructions.

Ningbo Ican Machines Co., Ltd.  
No. 77 Yunlin East Road, Gulin Town,  
Ningbo, China.  
[www.icanclave.com](http://www.icanclave.com)

European Representative:  
Icanclave Europe S.L  
Juan Ramon Jimenez 6  
Quart de Poblet, Valencia, Spain.

Document: Version 10T20000V2.10  
Subject to technical changes

Save these instructions

# Content

1. General	4	4 Scope of manual 4 Intended use 4 General safety instructions 4 Standards and directives 5 Symbols
2. Description of the sterilizer	5	5 Control panel 6 Sterilizer views 7 Technical specification 7 Packing content
3. Installation	7	7 General conditions 8 Power supply connection 8 Location requirements
4. Setup	8	8 Fill the distilled water tank 9 Preparation of the sterilization materials 10 Basic set 12 Advance set
5. Operation	14	14 Load the sterilization chamber 14 Select the program 14 Start the sterilization program 15 End of cycle 15 Manually interruption of the cycle 16 Delay start cycle 17 Test Program 18 Descale 19 Data 19 Print report 20 Print Labels 20 Save report
6. Maintenance	20	21 Clean the distilled water tank 21 Replacement of the bacteriological filter 21 Clean Chamber, trays and tray Rack 22 Door adjustment 22 Replacement of the door seal ring 22 The drain valve
7. Troubleshooting	23	23 Troubleshooting
8. Transportation and storage	23	23 Transportation and storage conditions
9. Safety devices	24	24 Safety device description
11. Appendix	25	25 Water properties/characteristics 26 Diagrams of the sterilization programs

# 1 General

---

## Scope of Manual

---

This manual contains information concerning the installation, operation and maintenance of the steam sterilizers. To ensure proper performance of the sterilizer, the instructions given in this manual should be thoroughly understood and followed.

Keep the manual near the sterilizer in an accessible location for future reference.

## Intended Use

---

The steam sterilizer described in this manual is intended for the sterilization in all medical, dental, beauty, vet and tattoo fields of the following types of instrument loads: solid, porous, hollow loads type A and hollow loads type B, un-wrapped, single wrapped and double wrapped, liquid, that are compatible with steam sterilization.

## General Safety Instructions

---

- Read and understand this manual before attempting to install or operate the sterilizer.
- Make sure that all the installation conditions are fully complied with.
- Ensure that the voltage agrees with the supply voltage specified on the supply on the type plate of the sterilizer.
- This appliance must be grounded. Connect only to a properly grounded outlet.
- Do not cover or block any openings on this appliance.
- Use this appliance only for its intended use as described in this manual.
- Do not exceed the maximum weight limit of the loads specified in this manual.
- Do not operate this appliance if it has a damaged cord or plug if it is not working properly or if it has been damaged or dropped.
- Never put into the sterilizer inflammables or explosive products.
- The sterilizer may not be operated in areas in which gas or any other explosive volatile substance is present.
- Installation and repair work should only be performed by authorized service technicians. Work by unqualified persons could be dangerous and may void the warranty.

## Standards and directives

---

The steam sterilizers were designed and produced in conformity with the following directives and standards:

### Directives:

97/23/CE Pressure equipment.

93/42/EEC Medical devices (class II b).

### Standards:

EN 13060 Relative to small steam sterilizers.

EN 61010-1 Safety regulations for laboratory devices - Part 1: General regulations.

EN 61010-2-040 Safety regulations specific to sterilizers used in the processing of medical material.

EN 61326-1 Electromagnetic compatibility regulations for laboratory devices.

## Symbols

For safe operation, please pay close attention to the alert symbols below which can be found on the sterilizer and throughout this manual.



Important information (Caution)



Hot surface







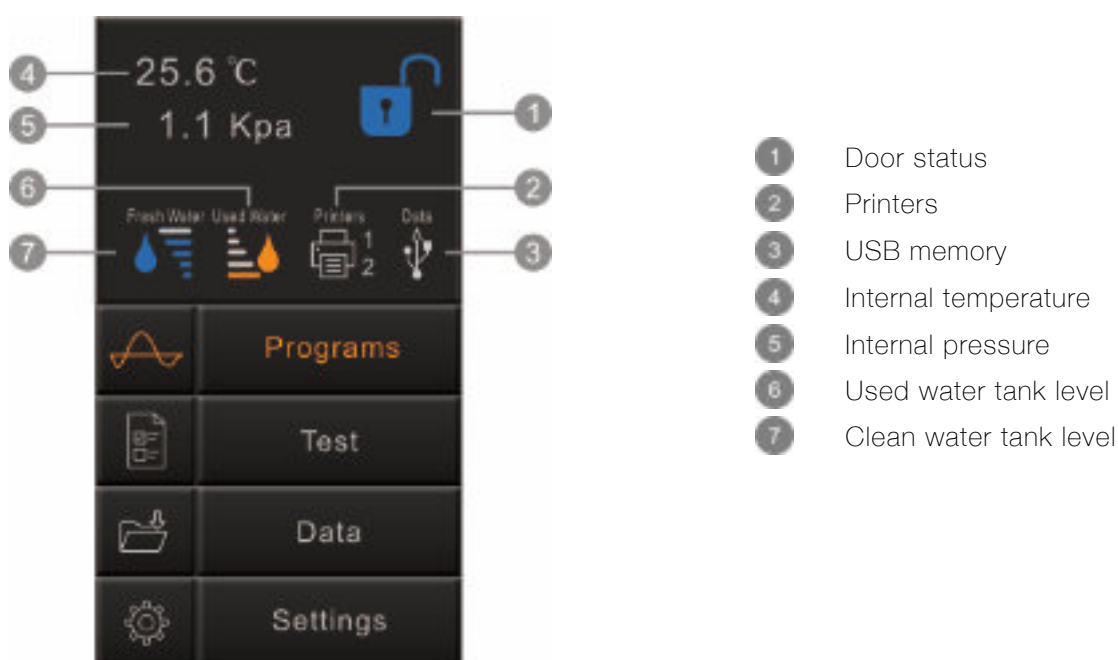

Ground connection

## 2 Description of the sterilizer

### Control panel



	Door closed / Tap to open the door		The door is open
	Fill the tank if it is flashing		From an external container Tap until (filling the tanks) appears
	Drain the tank if it is flashing		The capacity is 1.5 liters
	1 Report printer		Grey = No connected / no paper Green = Ready
	2 Label printer		Grey = No connected Red = No paper Green = Ready
	USB memory		Grey = No connected Green = Ready

## Sterilizer views

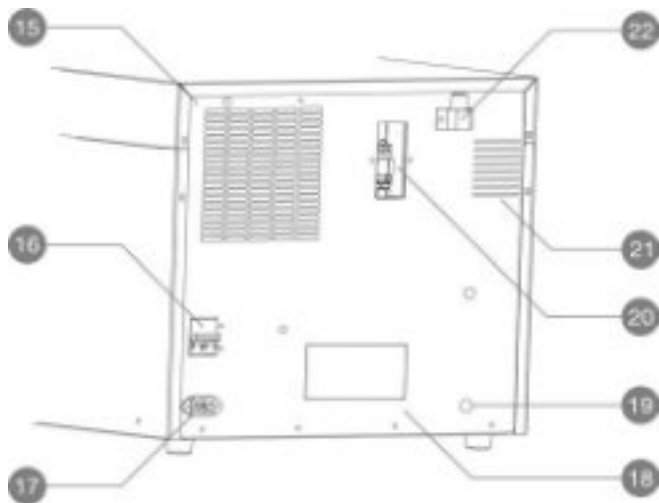
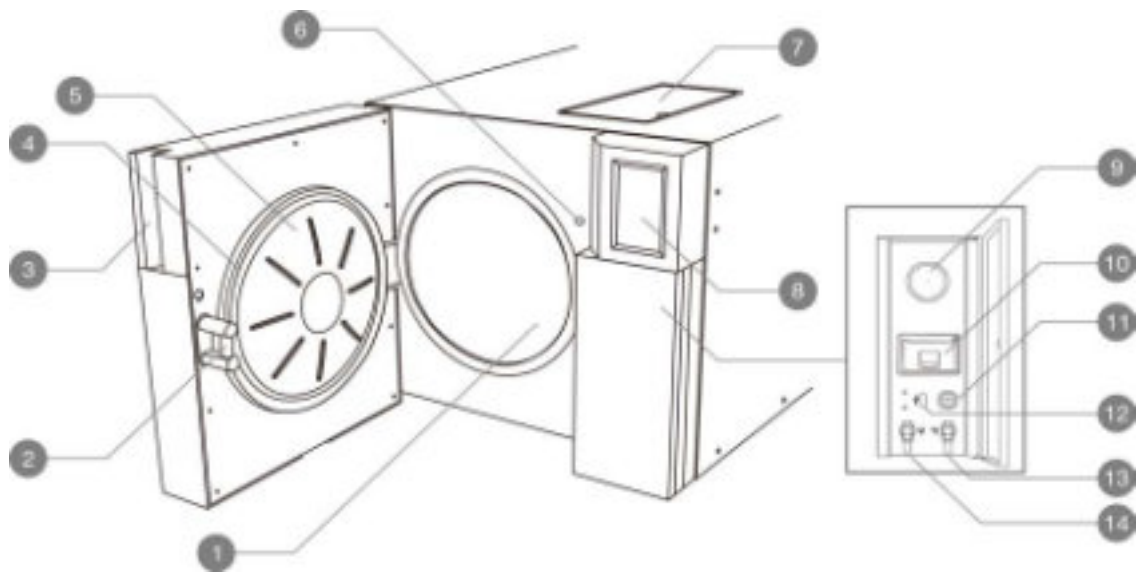





	Date of manufacture
SN	Manufacture number
	Manufacturer Name
	Manufacturer Address
	EC-Representative Name
	EC-Representative Address

1. Chamber	9 . Air filter	17. Power socket
2. Door lock	10. Printer	18. Rating plate
3. Door handle	11. Main switch	19. Distilled water tank (out)
4. Door seal ring	12. USB port	20. Safety valve
5. Door	13. Distilled water tank (Inn)	21. Valves vent
6. Door switch	14. Used water tank	22. Used water tank Vent
7. Distilled water tank	15. Condenser vent	
8. Touch screen	16. Circuit breaker	

## Technical specifications

Model	STE-18-T	STE-23-T
Chamber (mm)	247 x 350	247 x 450
Overall dimensions (mm)	483(W)*450(H)*635(D)	483(W)*450(H)*635(D)
Net Weight (kg)	50	53
Nominal power (VA)	2300	2300
Rated Voltage	220-240;50 Hz	220-240;50 Hz
Sterilization temperatures	121°C/134°C	121°C/134°C
Capacity of the distilled water tank	4 L (Water at level Max.) Approx.	
	0.8L (Water at level Min.) Approx.	
Circuit breaker	F16A /400 V	
Operation temperature	5°C ~ 40°C	
Operation relative humidity	Max. 80%, non-condensing	
Max. Noise level	<70 dB	
Atmospheric pressure	76 kPa ~ 106 kPa	

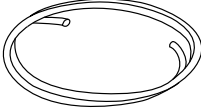
## Packing content

Item	Accessories	Quantity
1	Instruments tray 	5
2	Instruments tray rack 	1
3	Draining hose 	2
4	Door Seal 	1
5	Try handle	1
6	Instructions Manual	1
7	Calibration certificate	1

## 3 Installation

### General conditions

- Position the device on a plane surface with a minimum capacity of 60 kgs.
- The sterilizer should be placed on a level worktable.
- Leave at least 10 cm between the device rear part and the wall. The clearance required to open the door is 40cm.
- Position the sterilizer at such a height as to make it possible for the operator to check the whole sterilization chamber and carry out the normal cleaning operations.
- The room where the device is installed must be sufficiently ventilated.
- Do not install the device near washing basins, taps, etc. where it is likely to be splashed.
- Do not lean on the door when it is opened.
- Do not place trays, papers, fluid containers or other objects on the sterilizer.

## Power supply connection

---

Check the label on the back panel of sterilizer to verify the voltage rating for the unit. Failure to connect the sterilizer to an appropriate power supply could result in damage to the unit and electrical shock to personnel.

Plug power cord into a properly polarized and grounded receptacle rated. A dedicated circuit only used for the sterilizer is recommended. Never connect the device pin to reductions of any type.

## Location requirements (mm)

---

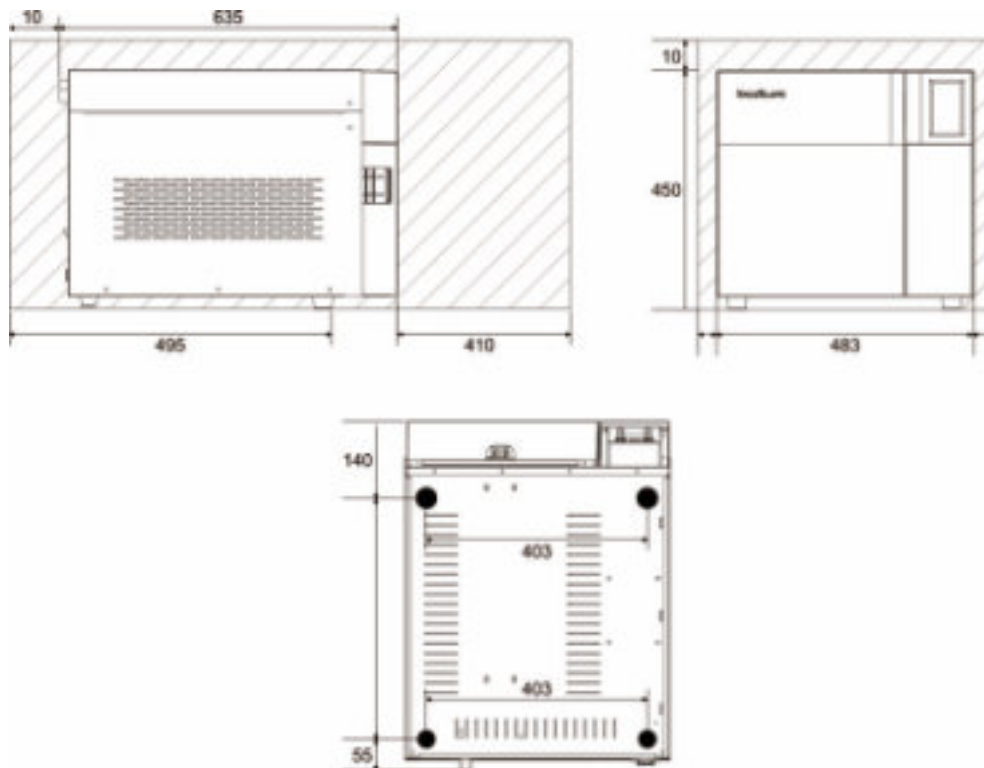

## 4 Setup

Switch On and open the door to remove all of the inner contents for unpacking.

Connect the power cord to an outlet of the appropriate voltage.

Turn on the main power switch on the right side. After switching on, the machine turns on the LCD and shows the door position, water level, working program, date, time, etc.

### Fill the distilled water tank

---

#### Manual water filling

---

When the level of distilled water reaches a minimum level, the distilled water tank icon will flash and beep three times.

Press the button on the tank lid and open it to the maximum position.

Fill it carefully with distilled water.

If exceeds the maximum level, an alarm will sound, and the distilled water tank icon will blink.



## From an external container

---

Connect the supplied tube to the front fitting of the sterilizer.

Insert the other end of the tube with the filter into the container with distilled water.

Tap the distilled water tank "fresh water" icon to operate the water pump and maintain it pressed until the message (filling the tank) appears.

The pump charges the clean water tank located at the top of the sterilizer, the capacity of the tank is 4.0 liters approx.

If after 240 seconds the tank has not reached the maximum level, the pump will stop, and it will be necessary to press again the distilled water tank icon to finish filling the tank.

Once the maximum level has been reached, the pump stops automatically.

## Fixed water feeding

---

When the lcanclave water system is connected, the device will fill the distilled water tank every time it reaches its minimum level.

To install the water system, follow the instructions given together with the lcanclave water device.

## Drain the distilled water tank

---

Attach the drain hose on a fitting connection located on the back of the sterilizer. Pull the connector to start the draining.

Attention: The capacity of the distilled water tank is approximately 4 liters.

## Drain the used water tank

---

Attach the drain hose on a quick fitting connection located inside the service door at the left.

Attention: The capacity of the used water tank is approximately 2 liters.

## Preparation of sterilization materials

---

For the most effective sterilization and to preserve the sample, please follow below:

- Clean instruments immediately after use.
- Treat the instruments by ultrasound cleaner.
- Residual chemicals left over after cleaning and disinfecting process may damage and corrode parts of the sterilizer, always rinse off the instruments using distilled water.
- Follow instrument manufacturer's guidelines and recommendations for handling and cleaning instruments prior to sterilization.
- Check the manufacturer's instructions as to proper procedure for sterilizing of each item.
- Arrange the samples of different materials on different trays or with at least 3cm of space between them.
- Clean and dry instruments thoroughly before placing them into tray.
- Always insert a sterilization paper or cloth between the tray and sample to avoid direct contact.
- Arrange the containers (glasses, cups, test-tubes, etc.) on one side or inverted position, avoiding possible water stagnation.
- Don't stack the trays one above the other or put them in direct contact with the walls of the sterilization chamber.
- Always use the instrument tray handle.
- Wrap the samples one by one or, if more tools have to be set in the same bag, verify that these are made of the same material.
- Don't use metallic clips, pins or other, as this jeopardizes the maintenance of the sterilizer.
- Don't overload the trays over the stated limit (see appendix 2).

## Basic Set

After you turn the sterilizer On, the main menu will appear, select "Settings" then "Basic Set".

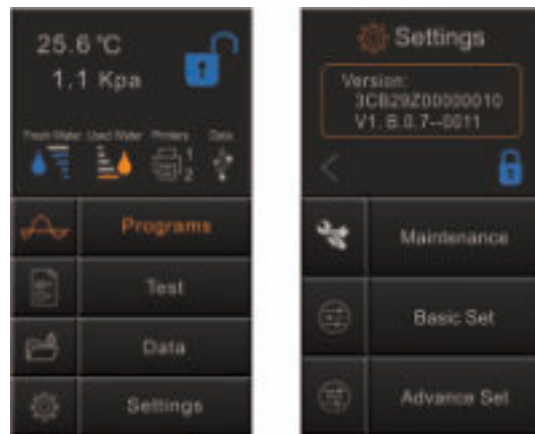

## Time & Date

Select "Time & Date"

The screen will show the current configuration.

Tap ">" to enter the menu.

Touch the parameter that needs to be change, it will light orange, by pressing (+/-) or by using the numbers adjust it. To save press "↵"

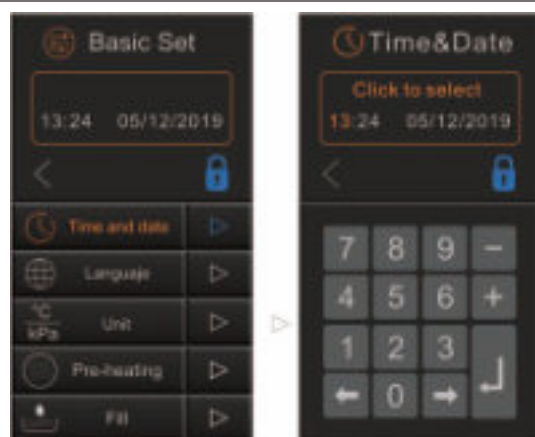

## Language

Select "Language"

The screen will show the current configuration

Tap ">" to enter into the menu.

Select the language, tap "<" to save and back.

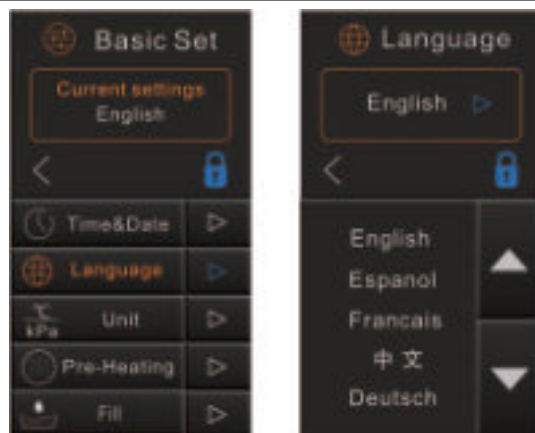

## Unit

---

Select "Unit".

The screen will show the current configuration.

Tap "▷" to enter the menu.

Select the parameter, the selected parameter will light orange.

Tap "<" to save and back.

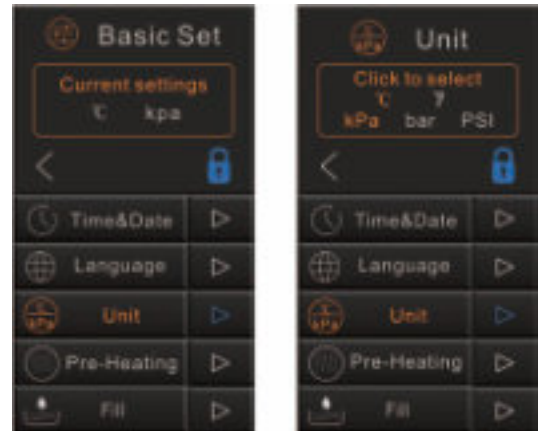

## Pre-Heating

---

Tap "Pre-heating" button.

The screen will show the current configuration.

Tap "▷" to enter the menu.

Tap ON or OFF to select.

tap "<" to save and back.

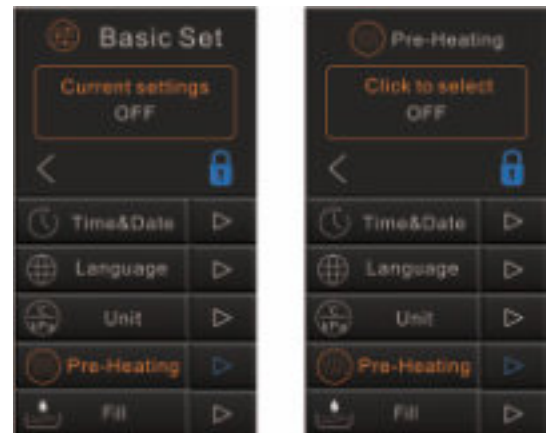

## Fill

---

Select "Fill".

Tap "▷" to enter the menu.

Tap the number 0~9 to set the automatic water filling time. (We recommend to set at "05:00").

If set at "00:00", the automatic water filling function will be OFF.

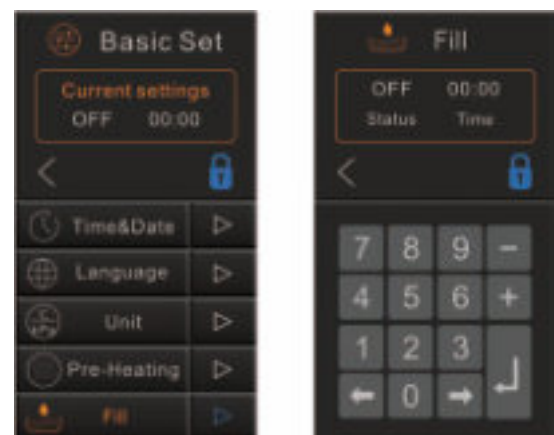

## Advance Set

---

Tap "Settings"  
then "Advance Set".  
Enter passwords  
" 111111"  
and tap "↵" enter the  
menu.

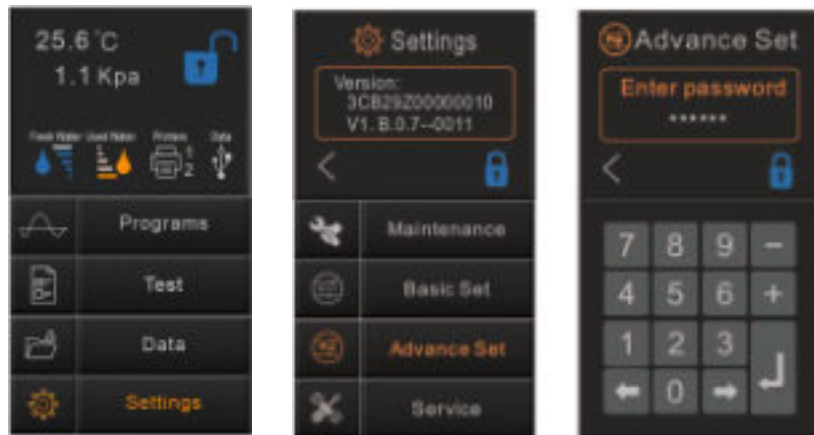

## Parameter

---

Select "Parameter".  
Tap "Click here to set  
cycle parameters" to  
enter the menu.  
The "Parameter" menu  
permits to set the  
following options:

"Sterilization time" and  
"Dry time".

Select the cycle name,  
for example "Quick".  
The screen will show the  
current configuration.

Tap "▷" to enter the menu.

Touch the parameter or by pressing "⇨" "⇧" select the number that needs to be changed, it will light red, or by pressing the numbers adjust it. To save press "↵"

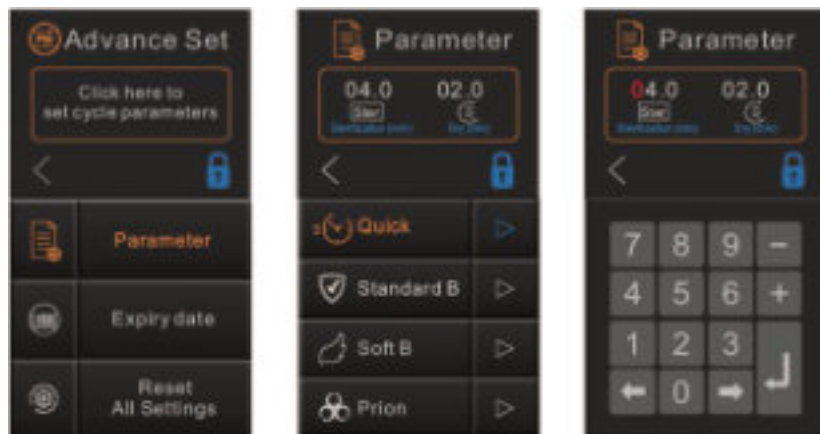

## Expiry date for label report

---

Select "Expiry date"  
Tap "Click here to set expiry date" to enter the  
menu.

By pressing "⇨" "⇧" select the number that to  
be changed, it will light red, or by pressing the  
numbers adjust it. To save press "↵".

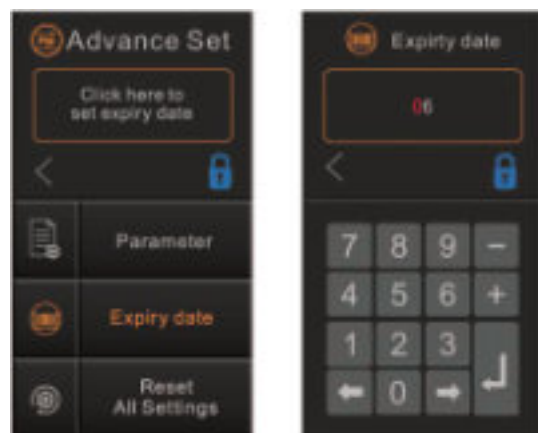

## Reset all settings

---

Select "Reset All Settings"  
Tap "Click here to reset all settings"  
The screen will show "confirm to reset all settings?"  
To confirm press "✓"  
To deny press "✗"

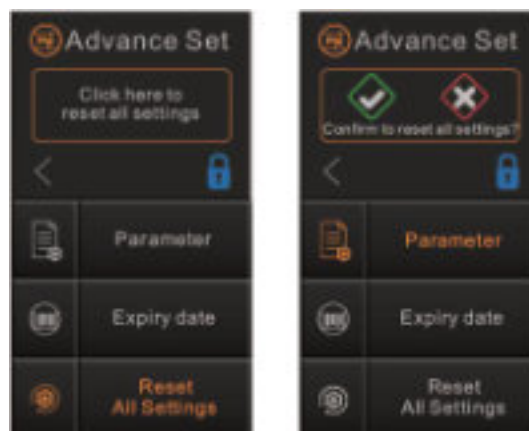

## Maintenance

---

Tap "Settings"  
then "Maintenance".  
You can see the  
information of how many  
days or cycles left for  
maintenance.



## 5 Operation

### Load

---

After selecting program, the materials to be sterilized can now be placed on the tray and placed inside the chamber by the tray handle. After the instruments are loaded, you may close the door.



### Select the program

---

After you turn the sterilizer On, the main menu will appear, select "Programs". Tap the program to select, in the screen will appear the information of selected program as the pressure, temperature, time (this may vary depending on the environmental conditions and the load), vacuum times, Sterilization time (holding time) and drying time.



### Start the sterilization program

---

After closing the door, tap "►" to start the cycle. The stage, conditions and the status of the cycle will appear on the display. The sterilizers will perform the program automatically. (see appendix 2).



## End of the cycle

Once the cycle is completed, "End" will appear at the end of the graphic, the printer will print out and the digital report saved in the USB memory is these are connected.

To open the door, tap to the door status icon.

If the label printer is connected (Optional) (See label printer), the icon will appear next to the door status icon.



**Caution:** Always use the tray handle to load or unload the tray into the sterilizer. Failure to do so can result in burning.



## If the label printer is connected

At the end of a successful cycle, if the label printer is connected, the printer icon will appear. Tap the icon to print the labels. Tap labels icon and select the number of copies, tap printer icon to print the labels.

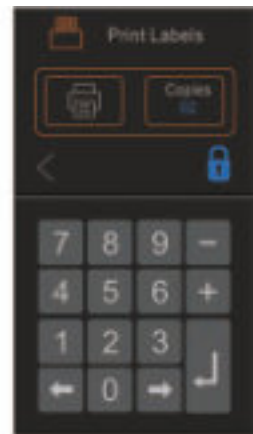
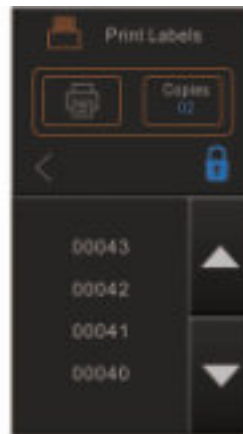

## Manually interruption of the cycle

To interrupt a started cycle prematurely, tap "Stop" and "✓" to confirm.



If the cycle is manually interrupted after it reaches the drying phase, the items inside the sterilizer may be considered sterile.

Note: Considering that the cycle has been interrupted during the drying phase the materials and instruments inside the chamber may be wet.



If the cycle is manually interrupted before it reaches the drying phase, the items inside the sterilizer must be considered not sterile.



Caution: Depending on the phase of the cycle, steam and water can escape from the sterilization chamber when you open the door.



## Delay start cycle

Tap "Delay Start" to schedule or modify a delay start cycle. The screen will show the current configuration.

Tap "▷" to enter in the configuration menu.

Select the program then tap "Tap to set a delay cycle".

Select the program then tap on the time and date and adjust it using the numeric keypad.

Tap "Disable" to set the delay start cycle once or daily. Tap "←" to save and back.

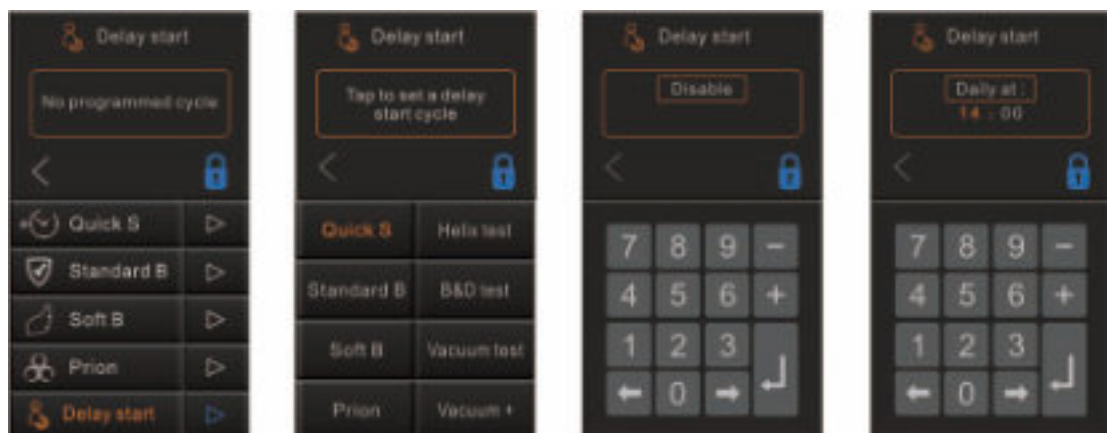



Once the cycle has been programmed a message icon will appear on the main screen.

Tap Message to review the parameters of the programmed cycle or/and to cancel it.

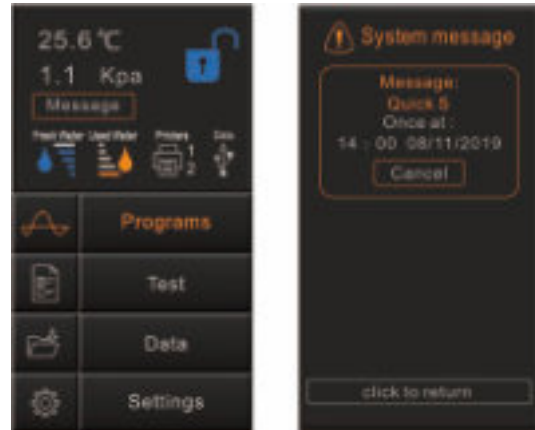

## Test Programs

### Helix Test

Tap Test from the main menu, select Helix test, in the screen will appear the information of selected Test program as the pressure, temperature, time (this may vary depending on the environmental conditions and the load), vacuum times, Sterilization time (holding time) and dry time.

Following the instructions of the test manufacturer. Put the Helix test into the chamber, then close the door and Tap “▷”

After finishing the cycle, you may check the indicator and evaluate the result according with the instructions of the test manufacturer.



### B&D test

Tap “Test” from the main menu, select “B&D test”, in the screen will appear the information of selected Test program as the pressure, temperature, time (this may vary depending on the environmental conditions and the load), vacuum times, Sterilization time (holding time) and drying time. Following the instructions of the test manufacturer.

Put the B&D test into the chamber, then close the door and Tap “▷”

After finishing the cycle, you may check the indicator and evaluate the result according with the instructions of the test manufacturer.

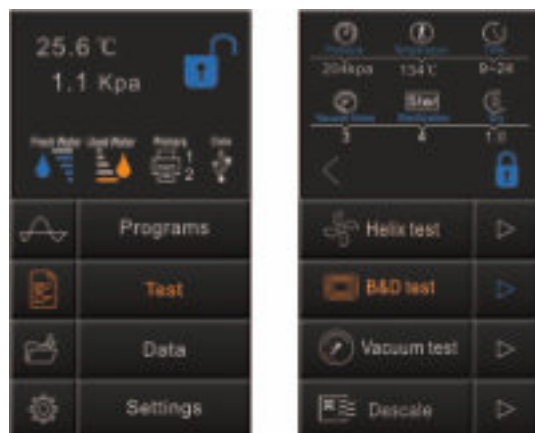

## Vacuum Test

Remove all instruments inside chamber before doing Vacuum Test.  
Tap "Test" from the main menu, select vacuum test.

Tap "Vacuum test" to select, in the screen will appear the information of selected test program as the pressure, temperature, time (this may vary depending on the environmental conditions and the load), vacuum

times, Sterilization time (holding time) and drying time. In compliance with EN 13060, the test requires that the air leakage rate less than or equal to 0.13 kPa/min. During 10 minutes: If leakage rate is not greater 0.13, it will show Success.

If the temperature difference between the max. Temperature and the Min. is above 3°C, it will show void. That means the result of the test is fail. You need run the vacuum test again after the chamber has cooled down.



## Descal

Mix the descaling powder with distilled water to make descaler according with the instruction of the descaling powder manufacturer.

Tap "Test" from the main menu, select descale. Tap "Descal" to select, and tap ">". Remove all instruments inside the chamber and close the door.

Empty the fresh water tank and fill with descaler which prepared as above, to 2/3 of the water tank.

Tap , start descaling, it will take around 25 minutes.

After descaling, empty the fresh water tank and fill with distilled water.

Tap , start flushing, it will take around 8 minutes.

After flushing, the cycle "Descal" is end.



## Data

---

The internal memory will store the information of the last 9999 cycles.

## Print report

---

Select Data from the main menu and tap Print report, it will show the current status.

Tap "▷" to enter in the menu.

Select the cycle and Tap Print.

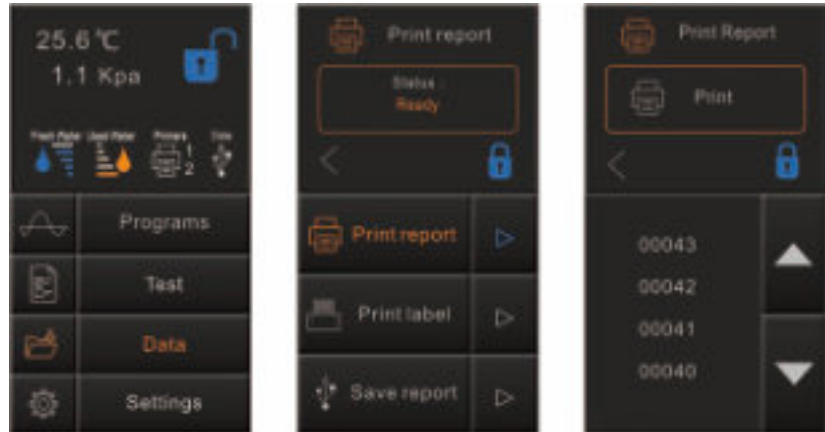

## Sample of a printer report

---

==		
Program: WRAPPED		
Temperature: 134C		
Pressure: 206.0kPa		
Drying Time: 08Min		
Holding Time: 4.0Min		
-----		
	Time	Temp. Pressure
Start	12:28:17	089.0C
T1:	12:31:32	087.1C -075.0kPa
T2:	12:33:43	110.2C 052.0kPa
T3:	12:36:37	088.9C -075.0kPa
T4:	12:39:20	114.7C 053.7kPa
T5:	12:43:37	087.9C -075.0kPa
T6:	12:50:40	134.8C 206.0kPa
TS:	134.7C	209.5kPa
Max. Temperature:135.2C		
Min. Temperature:134.3C		
Max. Pressure:214.0kPa		
Min. Pressure:204.9kPa		
T7:	12:54:39	134.4C 211.4kPa
T8:	12:57:36	102.1C -060.0kPa
T9:	12:59:54	098.2C -060.0kPa
End	13:04:07	102.4C
-----		
Cycle No.: 00017		
Ster. Value: Success		
Date: 2017-06-07		
SN:E54723		
Operator:		
v 2B00V2.5		
==		

## Print labels

---

Select Data from the main menu and tap “Print labels”, it will show the current status. Tap “▶” to enter in the menu. Select the cycle number and select the number of copies, tap printer icon to print the labels.

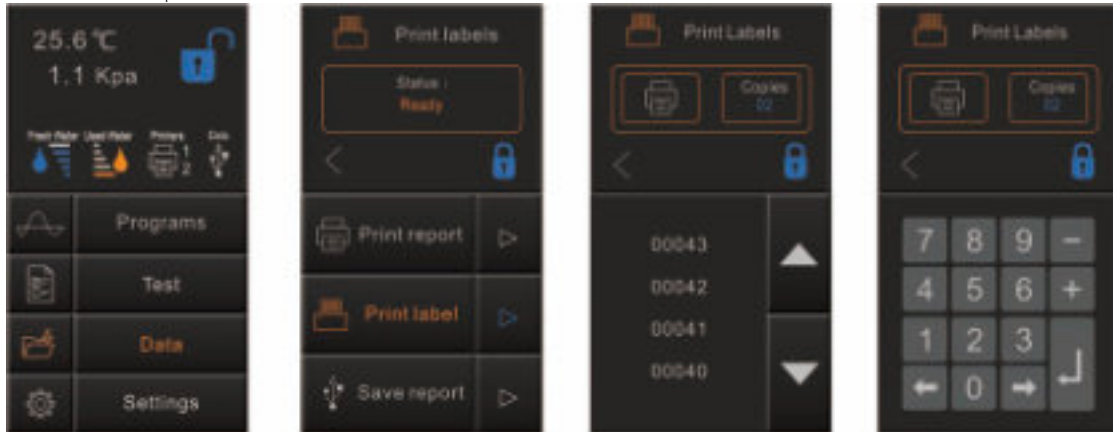

## Save Report

---

Select Data from the main menu and tap “Save Report”, it will show the current status. Tap “▶” to enter in the menu.

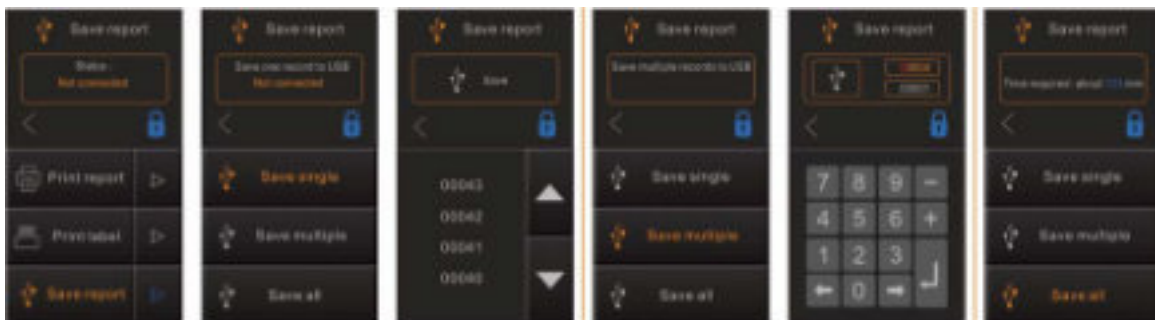

E.g.  
If the serial number of the steam sterilizer is E00001 and the cycle number is 0012.

The file name of the file will be 01001200.log  
The first two numbers represent machine number.  
The middle four numbers represent cycle number.  
The last two numbers represent error code.  
00: no error; 01: error E01

---

## 6 Maintenance

To ensure proper operation and maximum steam sterilizer life, carefully follow all recommendations for periodic maintenance.  
One of the most important steps you can take to prevent problems with your sterilizer is to use only distilled water.

Frequency	Number of cycles	Maintenance operation
Monthly	50	Clean the door seal
		Clean the filter inside the chamber and in the clean water tank
		Clean the chamber the trays and the rack
		Clean the external surface
Every 3 months	200	Clean the distilled water tank
Every year	800	Replace the door seal

Select Settings from the main menu and tap "Maintenance", to enter in the menu. Select the item to check the information.



### Clean the distilled water tank

Disconnect the main cable.

Drain the tank completely using the drain connector at the back of the sterilizer and leave it connected into the connector in an open position.

Clean the internal surface with a soft sponge and a small soft brush for the areas difficult to reach using and a distilled water.

Remove the filter and clean it with a small soft brush and mild soap, rinse it with distilled water, and put it back in to the position.

### Replacement of the bacteriological filter.

The bacteriological filter is in the back of the sterilizer. Unscrew the filter by hand anti-clockwise.

Place the new bacteriological filter.

Screw the new filter by hand clockwise.

Note: Do not operate sterilizer without filters in place.

### Clean chamber, door seal ring, trays, and tray rack.

Remove the trays and tray rack from the chamber.

Clean trays, rack and inside of the chamber with mild soap.

Rinse the trays, rack and inside of the chamber with a smooth cloth and distilled water.

Examine door seal for possible damage.

Clean door seal and mating surfaces with a damp cloth.

Note: Do not use bleaching agents or any abrasive materials or substances in the chamber. Failure to comply may cause damage to the chamber and/or other components.



Caution: To prevent burns, let the unit cool before cleaning gaskets and touch the surface.

## Door adjustment

---

Under normal circumstances, the chamber door does not require adjustments. However, if the seal fails (resulting in steam leaking from the front of the chamber), you may adjust it.

Open the door, insert your finger into the bottom of the door, and pull the ring to unlock the mechanism. Turn the lid counterclockwise to tighten it. If it is too tight, you may also turn the lid clockwise to loosen it.

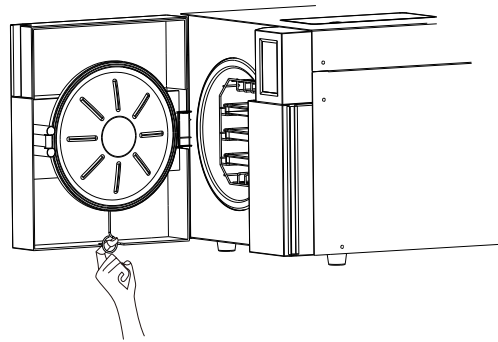

## Replacement of the door seal ring

---

Open the chamber door. Remove the door seal ring carefully by hand. Clean the door seal ring carefully with a smooth cloth with distilled water. Moisten the new seal with distilled water. Insert the new seal and tap in sequence as follows:



Press in the top and bottom of the door seal.



Press in the left and right sides of the door seal.



Press the remaining sections of the seal.



Caution: Please ensure the chamber and the door are cold prior to replacing the seal ring.

## The drain valves

---

To drain the water from the used water tank or to fill the tank from an external container, insert the connector attached to the silicone tube until a click is heard. To disconnect the connector, press the metal button.



## 7 Troubleshooting

---

Code	Description	Proposed solution
E1	Steam generator temperature sensor error.	Power off & run a new cycle Contact your supplier if error persists.
E2	Inner temperature sensor error.	Power off & run a new cycle Contact your supplier if error persists.
E3	Temperature sensor of the chamber wall error.	Carefully ensure that the chamber wall is heated and contact your supplier.
E5	Fail to release the pressure.	Power off & run a new cycle Contact your supplier if error persists.
E6	Door lock problem during the cycle.	Make sure you had closed the door properly, check the door switch.
E9	Failure to hold temperature.	Ensure the distilled tank isn't empty. Check the inner temperature sensor. Check somewhere for leaking.
E10	The door locking system doesn't work.	The electromagnet of locking system doesn't work. The switch of locking system doesn't work.
E11	Failure to preheat the steam generator.	Power off & run a new cycle Contact your supplier if error persists.
E12	Failure to preheat the chamber.	Power off & run a new cycle Contact your supplier if error persists.
E13	Vacuum failed.	Power off & run a new cycle Contact your supplier if error persists.
E20	Program manually interrupted	Reset the error from main screen.
E21	Failure to reach the holding time. (sterilization time)	Check somewhere leaking inside the sterilizer. Contact your supplier if error persist.
E22	Vacuum test failure	Somewhere is leaking. Check the door seal. Or contact your supplier if error persists.
E23	Result of vacuum test is void	The temperature of the chamber is high. Try again after the chamber has cooled down.
E24	It takes too long time to enter the next status.	Check somewhere leaking. Or contact your supplier if error persists.
E27	The vacuum test fails.	Switch off. Then switch on after the chamber cool down and try again.
E28	The pressure is overload.	Power off and contact your supplier if error persists.

## 8 Transportation and storage

---

Switch off the sterilizer before transportation or storage.  
Pull out the plug. Let the machine cool down.  
Drain the distilled water tank and the used water tank.

Conditions for transport and storage  
Temperature: -20°C ~ +50°C  
Relative humidity: ≤ 85%  
Atmospheric pressure: 50kPa~ 106kPa.

## 9 Safety devices

---

1. Main breaker: Protection of the instrument against possible failures of the heating resistor.  
Action: Interruption of the electric power supply.
  
2. Thermal cutouts on the main transformer winding: protection against possible short circuit and main transformer primary winding overheating  
Action: Temporary interruption of winding.
  
3. Safety valve: Protection against possible sterilization chamber over-pressure.  
Action: Release of the steam and restoration of the safety pressure.
  
4. Safety micro-switch for the door status: Comparison for the correct closing position of the door.  
Action: Signal of the wrong position of the door
  
5. Thermostat on chamber heating resistors: Protection for possible overheating of the chamber heating resistors.  
Action: Interruption of the power supply of the chamber resistors.
  
6. Thermostat on steam generator heating resistors: Protection for possible overheating of the steam generator heating resistors.  
Action: Interruption of the power supply of the steam generator resistors.
  
7. Door safety lock: Protection against accidental opening of the door.  
Action: Impediment of the accidental opening if the door during the program.
  
8. Self-leveling hydraulic system: Hydraulic system for the natural pressure leveling in case of manual cycle interruption, alarm or blackout.  
Action: Automatic restoration of the atmospheric pressure inside the chamber.



## Water properties / Characteristics

Description	Feed water	Condensate
Evaporate residue	$\leq 10\text{mg/l}$	$\leq 1.0\text{mg/kg}$
Silicium oxide $\text{SiO}_2$	$\leq 1\text{mg/l}$	$\leq 1.0\text{mg/kg}$
Iron	$\leq 0.2\text{mg/l}$	$\leq 0.1\text{mg/kg}$
Cadmium	$\leq 0.005\text{mg/l}$	$\leq 0.05\text{mg/kg}$
Lead	$\leq 0.05\text{mg/l}$	$\leq 0.1\text{mg/kg}$
Rest of heavy metals	$\leq 0.1\text{mg/l}$	$\leq 0.1\text{mg/kg}$
Chloride	$\leq 2\text{mg/l}$	$\leq 0.1\text{mg/kg}$
Phosphates	$\leq 0.5\text{ mg/l}$	$\leq 0.1\text{mg/kg}$
Conductivity	$\leq 15\mu\text{s/cm}$	$\leq 3\mu\text{s/cm}$
PH Value	5 – 7.5	5-7
Appearance	Colorless, clean	Colorless, clean
Hardness	0.02 mmol/l	0.02 mmol/l

Diagrams of the sterilization programs STE-18-T

Programs	Temperature (°C)	Pressure (kPa)	Holding time (min)	Total time (min)	Type	Max load (kg)	Max load per tray (kg)
Quick S	134	210	4	11-15	Unwrapped solid material	1.00	0.8
Standard B	134	210	4	30-49	Unwrapped solid material	4.50	1.50
					Single-wrapped solid or hollow material	4.00	1.20
Soft B	121	110	20	38~54	Unwrapped solid material	4.50	1.50
					Single-wrapped solid or hollow material	4.00	1.20
Prion	134	210	18	37-52	Unwrapped porous material	1.25	0.40
					Single-wrapped porous material	1.10	0.30
					Dual-wrapped porous material	0.75	0.25
					Single-wrapped hollow material	4.00	1.25
					Dual-wrapped solid and hollow material	2.00	0.60
Drying (optional)	—	—	—	1-20	—	—	—
B&D test	134	210	3.5	28-35	—	—	—
Helix test	134	210	3.5	28-35	—	—	—
Vacuum test	—	—	—	20-25	—	—	—

The time required for sterilizer to be ready for routine use after the power is switched is less than 5 minutes.

The max. Temperature of the 134°C sterilization cycle is 137°C

The max. Temperature of the 121°C sterilization cycle is 124°C

## Appendix 3

---

Diagrams of the sterilization programs STE-23-T

Programs	Temperature (°C)	Pressure (kPa)	Holding time (min)	Total time (min)	Type	Max load (kg)	Max load per tray (kg)
Quick S	134	210	4	15-20	Unwrapped solid material	1.20	0.8
Standard B	134	210	4	38-57	Unwrapped solid material	5.00	1.50
					Single-wrapped solid or hollow material	4.50	1.20
Soft B	121	110	20	46~62	Unwrapped solid material	5.00	1.50
					Single-wrapped solid or hollow material	4.50	1.20
Prion	134	210	18	45-60	Unwrapped porous material	1.25	0.40
					Single-wrapped porous material	1.10	0.30
					Dual-wrapped porous material	0.75	0.25
					Single-wrapped hollow material	4.00	1.25
					Dual-wrapped solid and hollow material	2.00	0.60
Drying (optional)	—	—	—	1-20	—	—	—
B&D test	134	210	3.5	28-35	—	—	—
Helix test	134	210	3.5	28-35	—	—	—
Vacuum test	—	—	—	20-25	—	—	—

The time required for sterilizer to be ready for routine use after the power is switched is less than 5 minutes.

The max. Temperature of the 134°C sterilization cycle is 137°C

The max. Temperature of the 121°C sterilization cycle is 124°C

---